

- PROPRIETARY INFORMATION -
NO USE OR REPRODUCTION MAY BE MADE OF
THIS DOCUMENT WITHOUT EXPRESS WRITTEN
PERMISSION OF UNIMICRON.

Revisions			
REV	ECN #	Description	Date
1		Preliminary	2022/05/31
2		Update the design to compliant with customer	2022/06/02
3		Add package information	2022/06/24

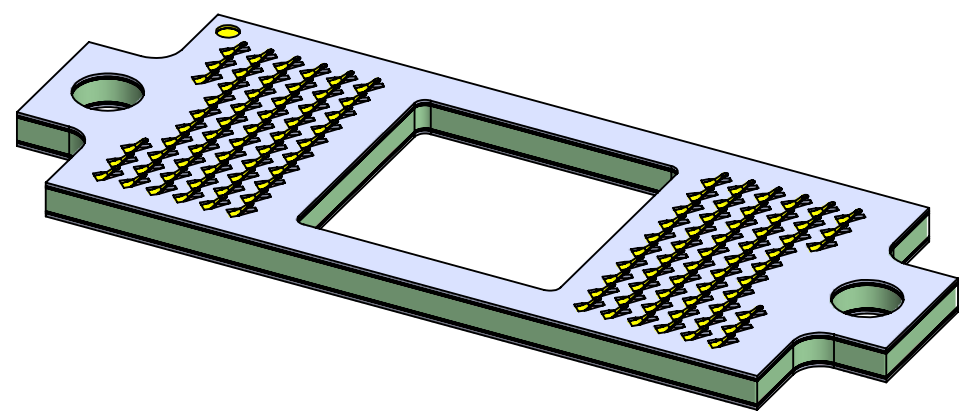
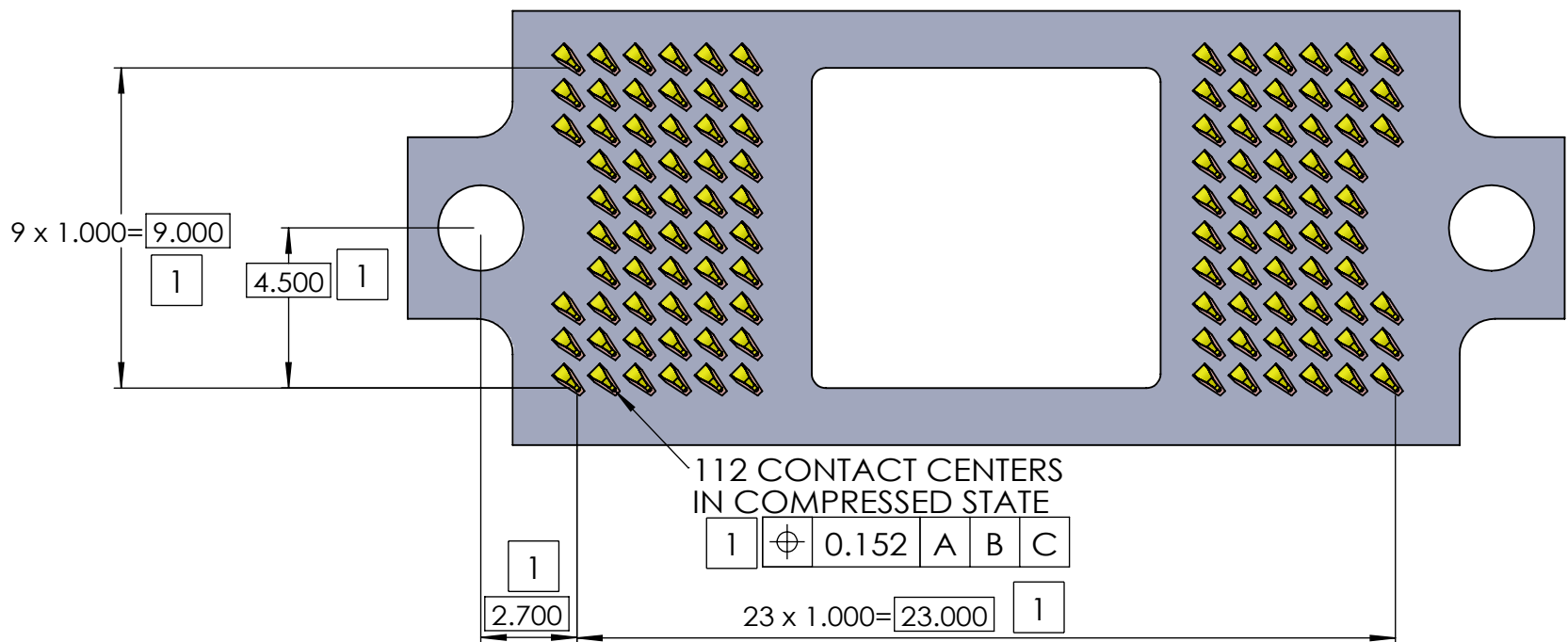
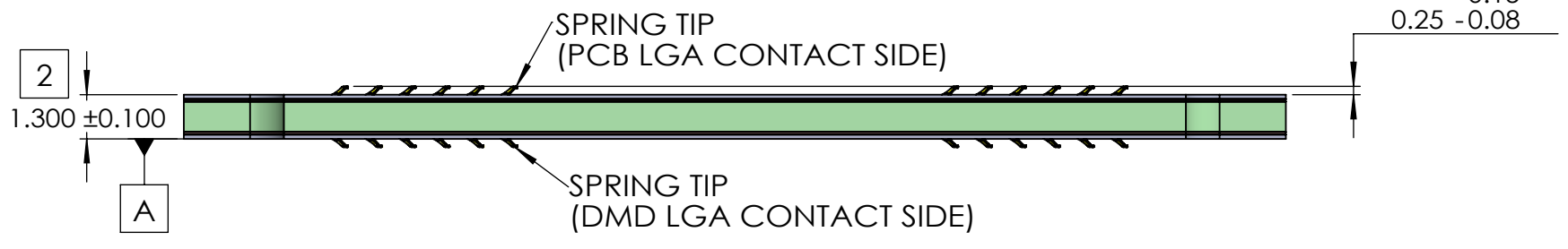
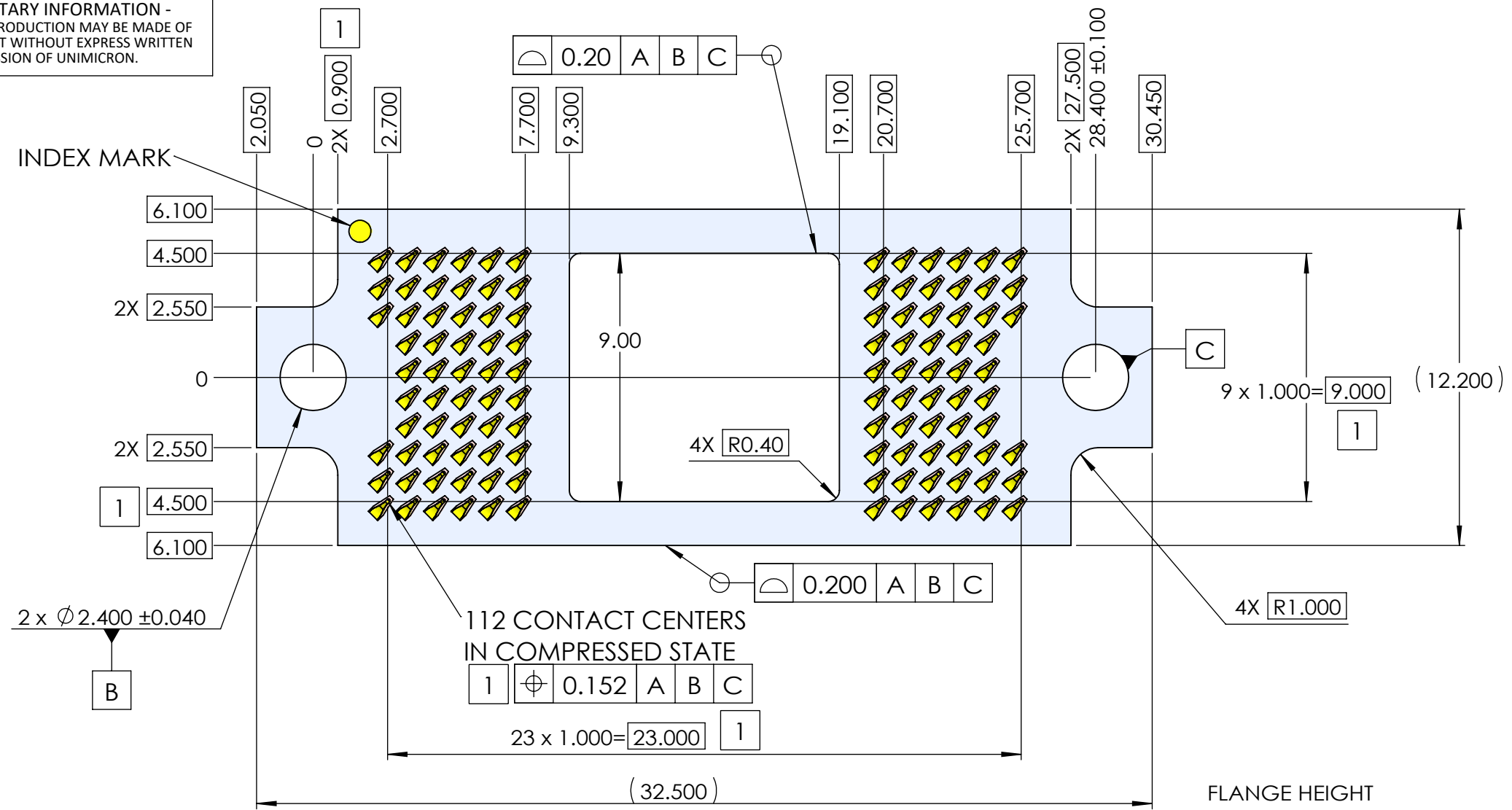

NOTES (UNLESS OTHERWISE SPECIFIED):

- 1 CENTER POSITION OF THE CONTACT AREA IN THE COMPRESSED STATE
- 2 HEIGHT WHEN CONTACTS ARE FULLY COMPRESSED BETWEEN DMD AND PCB

	DIMENSIONS ARE IN MM .X ± 0.15 .XX ± 0.10 .XXX ± 0.05 ANGLE: NO DEC ± 1° .X ± 0.5° .XX ± 0.25°		MATERIAL: FINISH: -- DRAWN BY: Winni Cheng 2022/06/24 CHECKED BY: Jason Wu 2022/06/24 ENGR APPR: MFG APPR: QA APPR:		TITLE: 112 pos "Automotive", 1.00mmP, LGA/LGA, 1.3mm thk DWG. NO.: BDX0112DMMSXAU00 SCALE: 5:1	
	THIRD ANGLE		SIZE: B+		REV: 3 SHEET 1 OF 3	

- PROPRIETARY INFORMATION -
NO USE OR REPRODUCTION MAY BE MADE OF
THIS DOCUMENT WITHOUT EXPRESS WRITTEN
PERMISSION OF UNIMICRON.

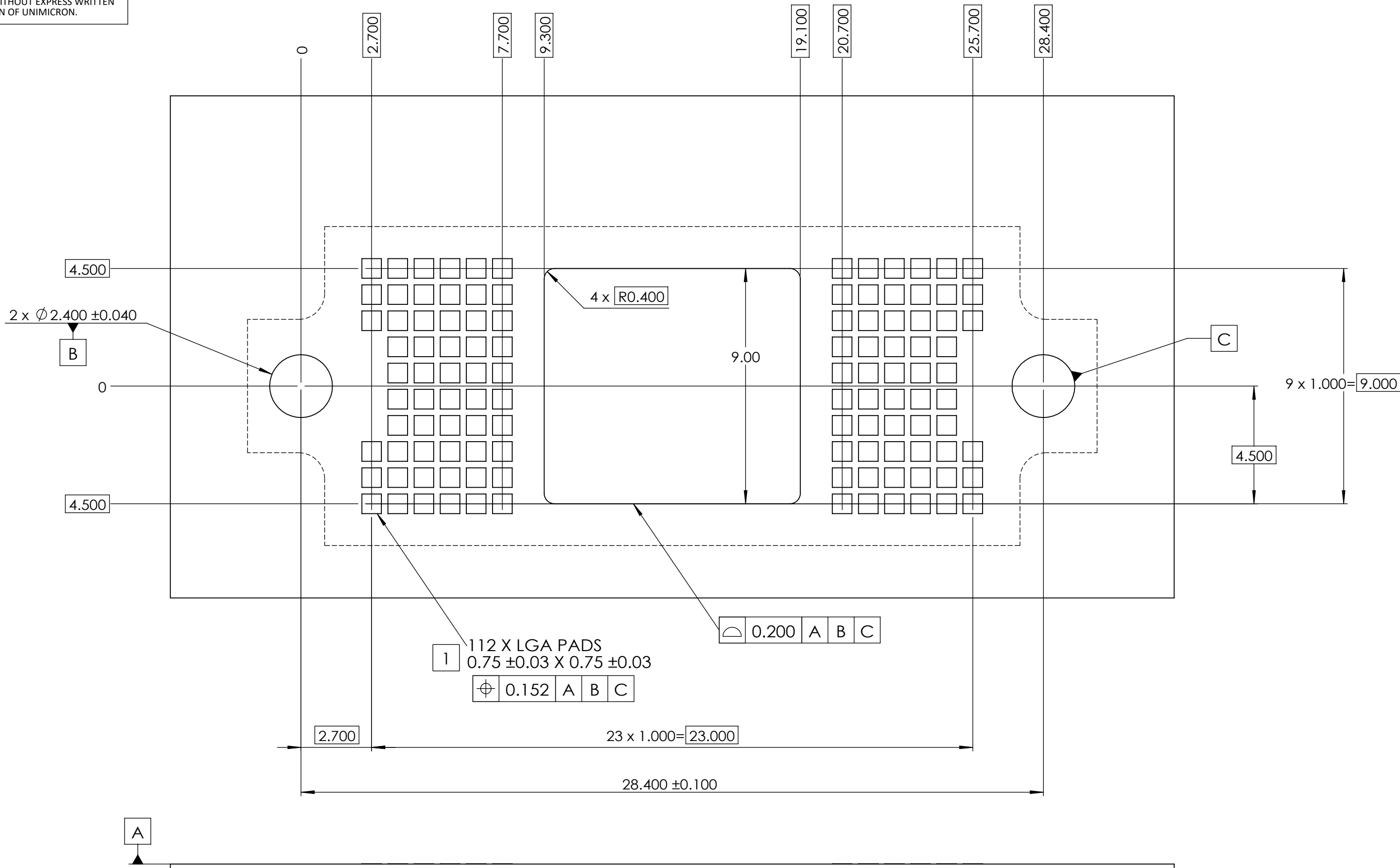

Recommended PCB PAD Layout

NOTES (UNLESS OTHERWISE SPECIFIED):

1 PADS TO BE ELECTROLESS NICKEL / IMMERSION GOLD(ENIG) PLATED.



DIMENSIONS ARE IN
MM
.X ± 0.15
.XX ± 0.10
.XXX ± 0.05
ANGLE: NO DEC ± 1°
.X ± 0.5°
.XX ± 0.25°
THIRD ANGLE

MATERIAL:
FINISH: --
DRAWN BY: Winni Cheng 2022/06/24
CHECKED BY: Jason Wu 2022/06/24
ENGR APPR:
MFG APPR:
QA APPR:

TITLE:
112 pos "Automotive", 1.00mmP,
LGA/LGA, 1.3mm thk

SIZE	DWG. NO.:	REV
B+	BDX0112DMMSXAU00	3
SCALE: 7:1		SHEET 2 OF 3

- PROPRIETARY INFORMATION -
NO USE OR REPRODUCTION MAY BE MADE OF
THIS DOCUMENT WITHOUT EXPRESS WRITTEN
PERMISSION OF UNIMICRON.

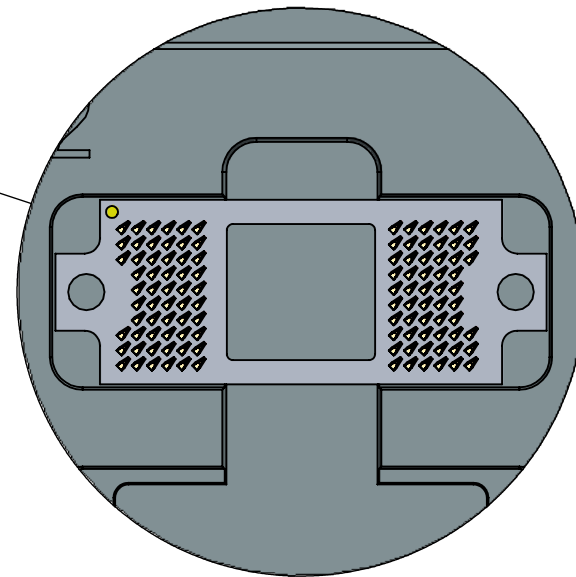
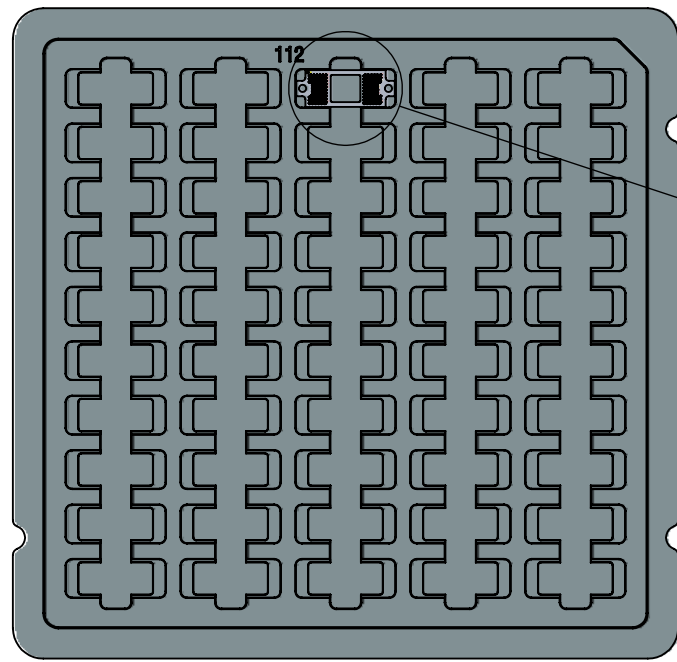

50 PCS/TRAY

CARTON LABELS

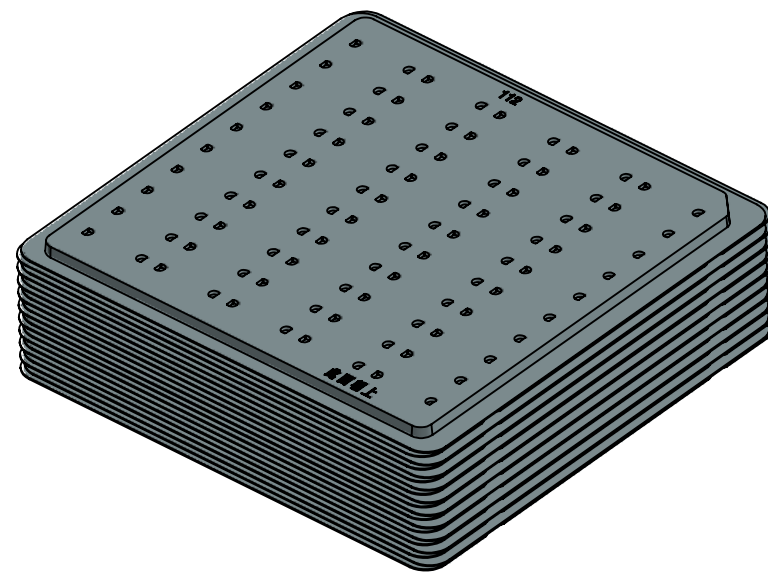
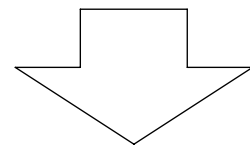
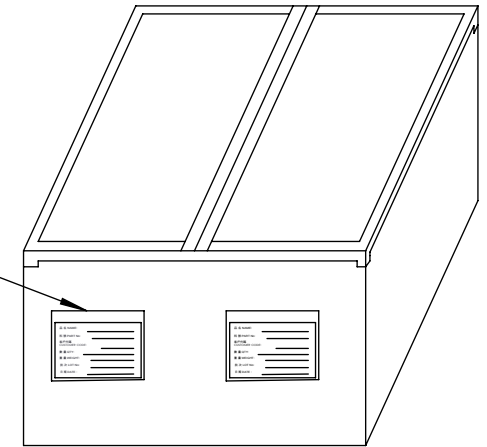

10 TRAY/PACKAGE

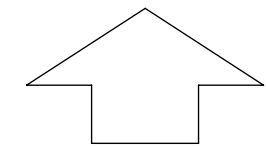

4 PACKAGE/CARTON

PE BAG

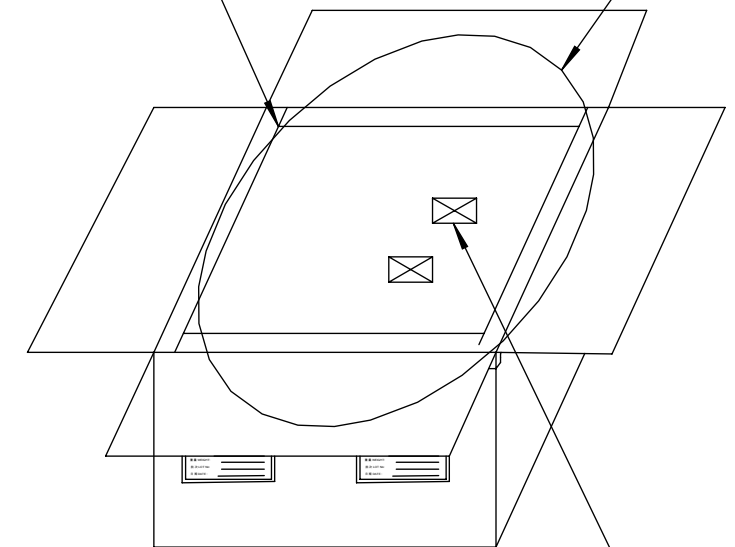

DRIER

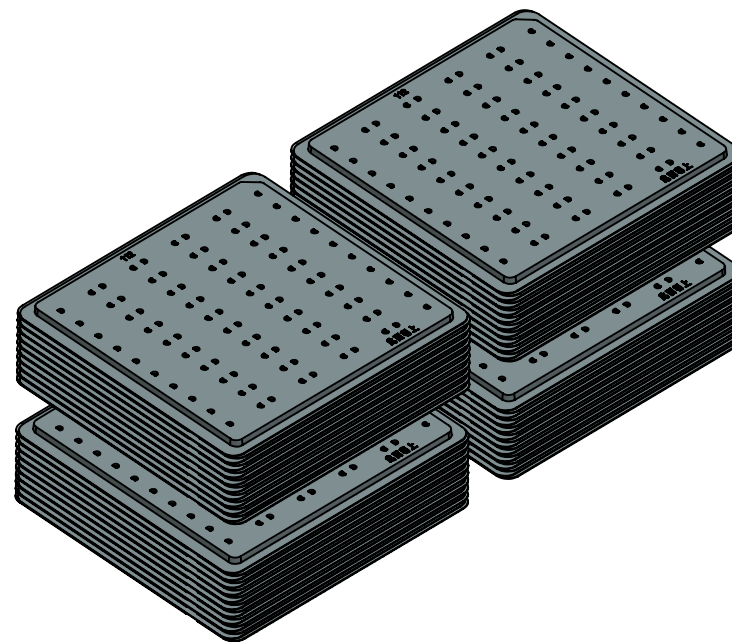
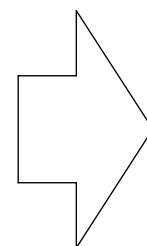

PACKAGE

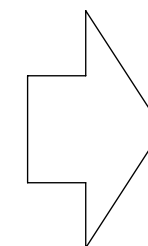

- Notes:
1. COMPONENT LOAD PER TRAY : 50PCS
 2. 10 TRAY/PACKAGE : 500PCS
4 PACKAGE/CARTON:
TOTAL : 2000PCS(40TRAY)/CARTON
(IF LESS THAN 2000 PCS WOULD STILL IN ONE CARTON)
 3. TRAY MATERIAL : PP or PVC
 4. Product tray size : 220 x 215 (mm)
 5. Carton size : 500 x 300 x 220 (mm)

	DIMENSIONS ARE IN MM [INCH]		MATERIAL:		TITLE:	
	.X ± 0.13 [0.005]	✓	FINISH: --		112 pos "Automotive", 1.00mmP, LGA/LGA, 1.3mm thk	
	.XX ± 0.08 [0.003]		DRAWN BY: Winni Cheng	2022/06/24	SIZE B+	DWG. NO.: BDX0112DMMSXAU00
	.XXX ± 0.04 [0.001]		CHECKED BY: Jason Wu	2022/06/24		
ANGLE: NO DEC ± 1° .X ± 0.5° .XX ± 0.25°		ENGR APPR:		SCALE: 2.5:1		
THIRD ANGLE		MFG APPR:		SHEET 3 OF 3		
		QA APPR:				