

- PROPRIETARY INFORMATION -  
NO USE OR REPRODUCTION MAY BE MADE OF  
THIS DOCUMENT WITHOUT EXPRESS WRITTEN  
PERMISSION OF NEOCONIX.

REVISIONS				
REV	ECN	DESCRIPTION	DATE	APPROVED
A	1231	PRODUCTION RELEASE	04-10-2019	WES TAO
B	1277	CHANGED TO PHILLIPS HEAD SCREW	10-30-2020	WES TAO
C	1285	ADDED STIFFENER BREAK TABS	03-01-2021	WES TAO

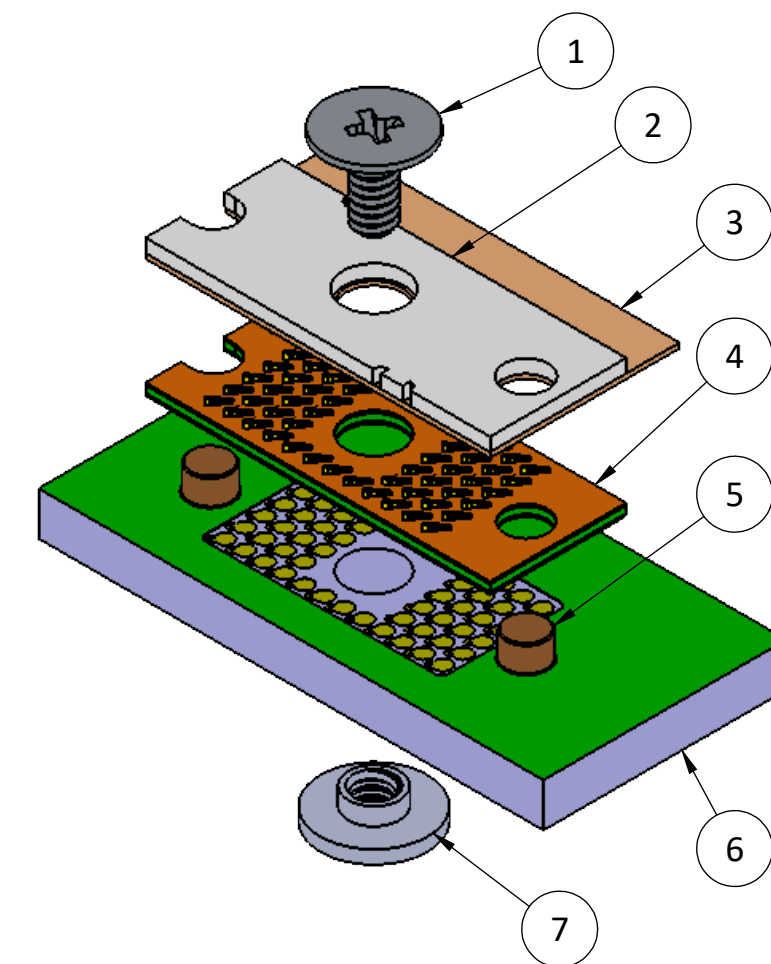
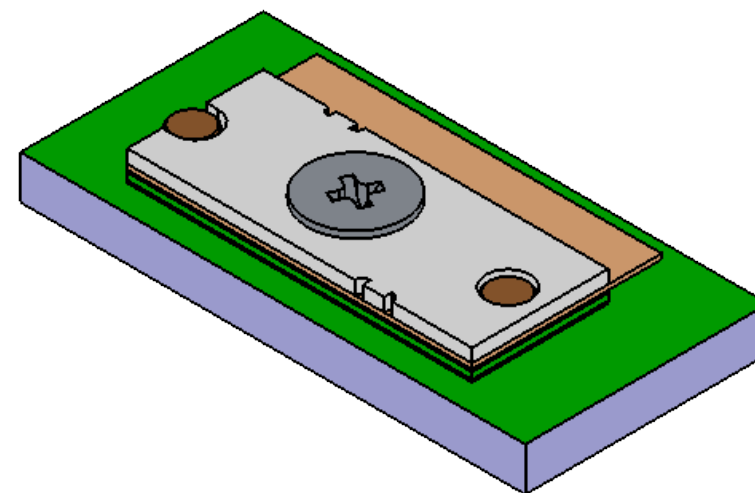
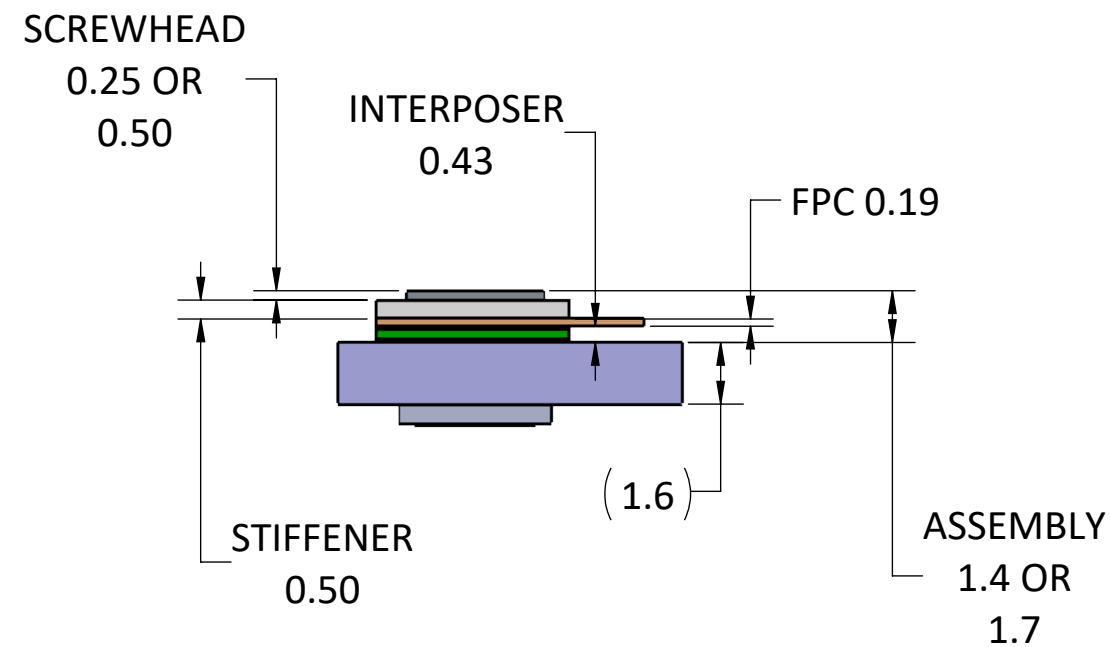
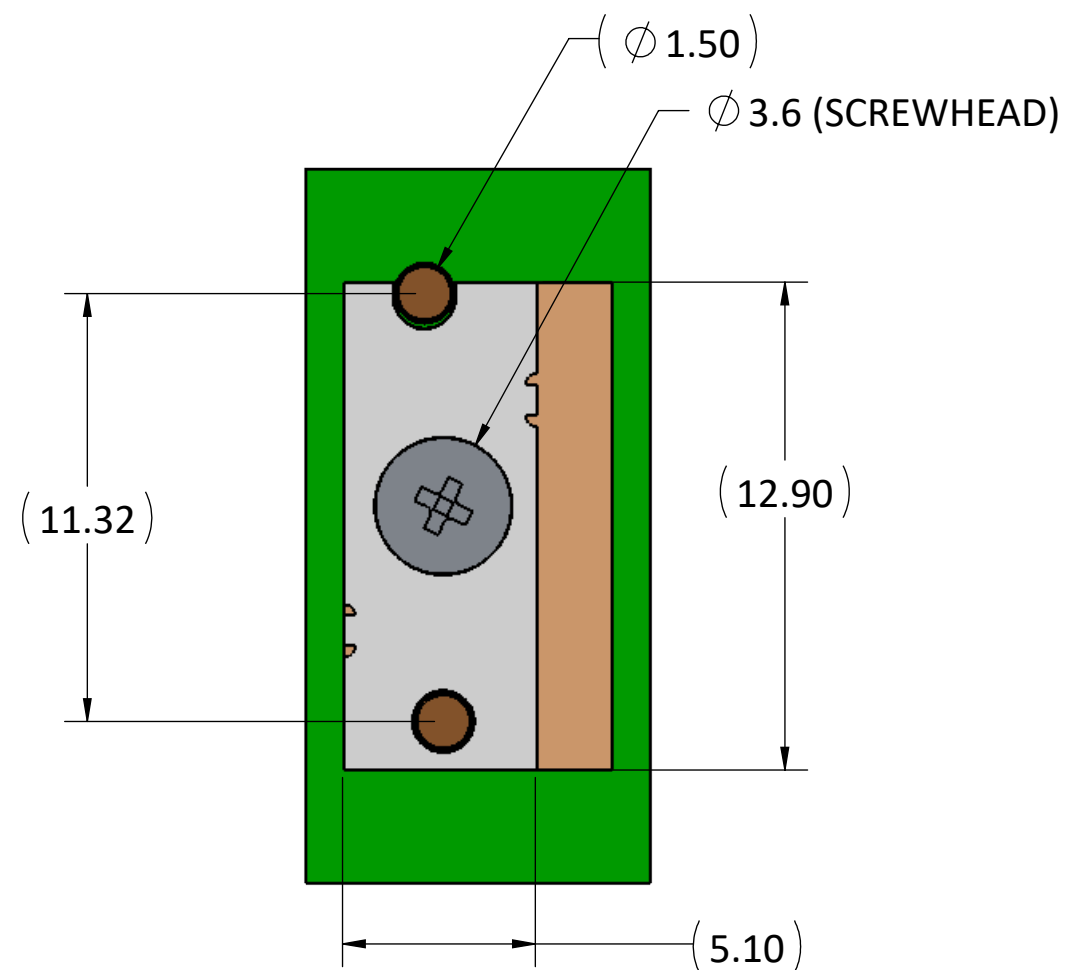

ITEM	DESCRIPTION	NEOCONIX P/N	QTY per ASSY
1*	SCREW, M1.4, L=3MM	B01-000614	1
	SCREW, M1.4, L=4MM	B01-000657	
	SCREW, M1.4, L=5MM	B01-000658	
2	STIFFENER	LPM-056A-STF	1
3	FPC	CUSTOM UPON REQUEST	1
4	INTERPOSER	LPM-056A	1
5	ALIGNMENT PIN	B01-000589	2
6	PCB	N/A - CUSTOMER SUPPLIED	1
7	SMT NUT, M1.4	B01-000581	1

\* SEE AS-000021 FOR RECOMMENDED SCREW LENGTH.  
ALL ITEMS ORDERED SEPARATELY.

**neconix**  
4020 MOORPARK AVENUE #108  
SAN JOSE, CA 95117 USA  
TEL: 408-530-9393 FAX: 408-530-9383

DIMENSIONS ARE IN  
MM [INCH]  
.X ±  
.XX ±  
.XXX ±  
ANGLE: NO DEC ±  
.X ±  
.XX ±  
THIRD ANGLE

MATERIAL:  
FINISH:  
DRAWN BY: JASON WU 03-19-2015  
CHECKED BY:  
ENGR APPR:  
MFG APPR:  
QA APPR:

TITLE:  
**LPM ASSEMBLY,  
56 POSITIONS LGA-LGA**  
DWG NUMBER:  
**LPM-056A-ASY**  
SCALE: 5:1  
SHEET 1 OF 5

- PROPRIETARY INFORMATION -  
NO USE OR REPRODUCTION MAY BE MADE OF  
THIS DOCUMENT WITHOUT EXPRESS WRITTEN  
PERMISSION OF NEOCONIX.

REVISIONS				
REV	ECN	DESCRIPTION	DATE	APPROVED
A	1231	PRODUCTION RELEASE	04-10-2019	WES TAO

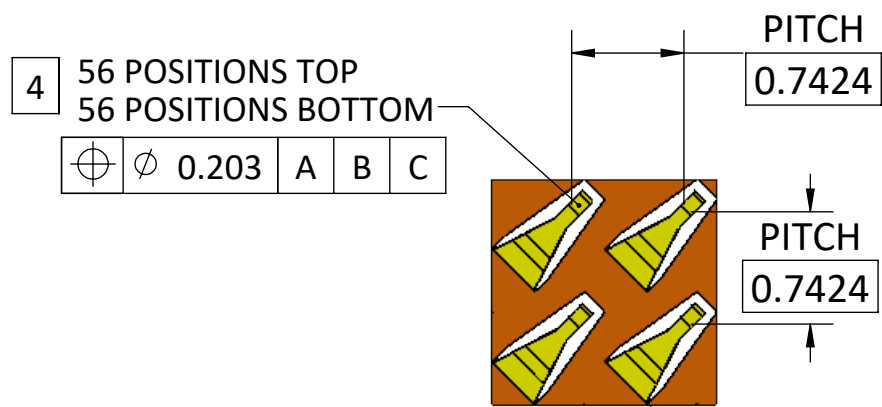

DETAIL B  
SCALE 20 : 1

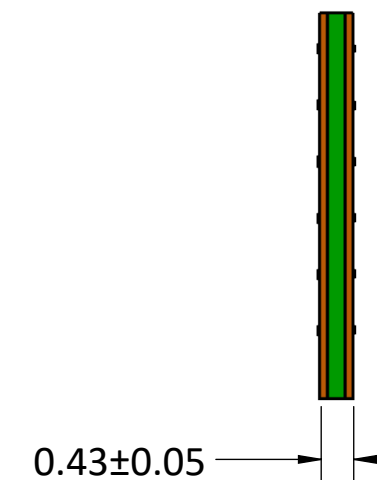
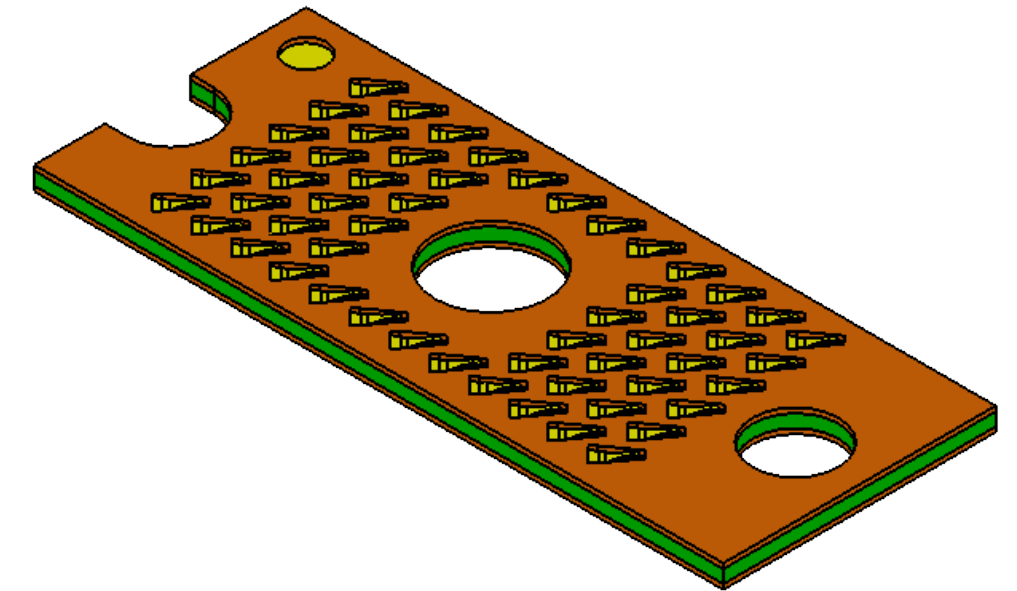
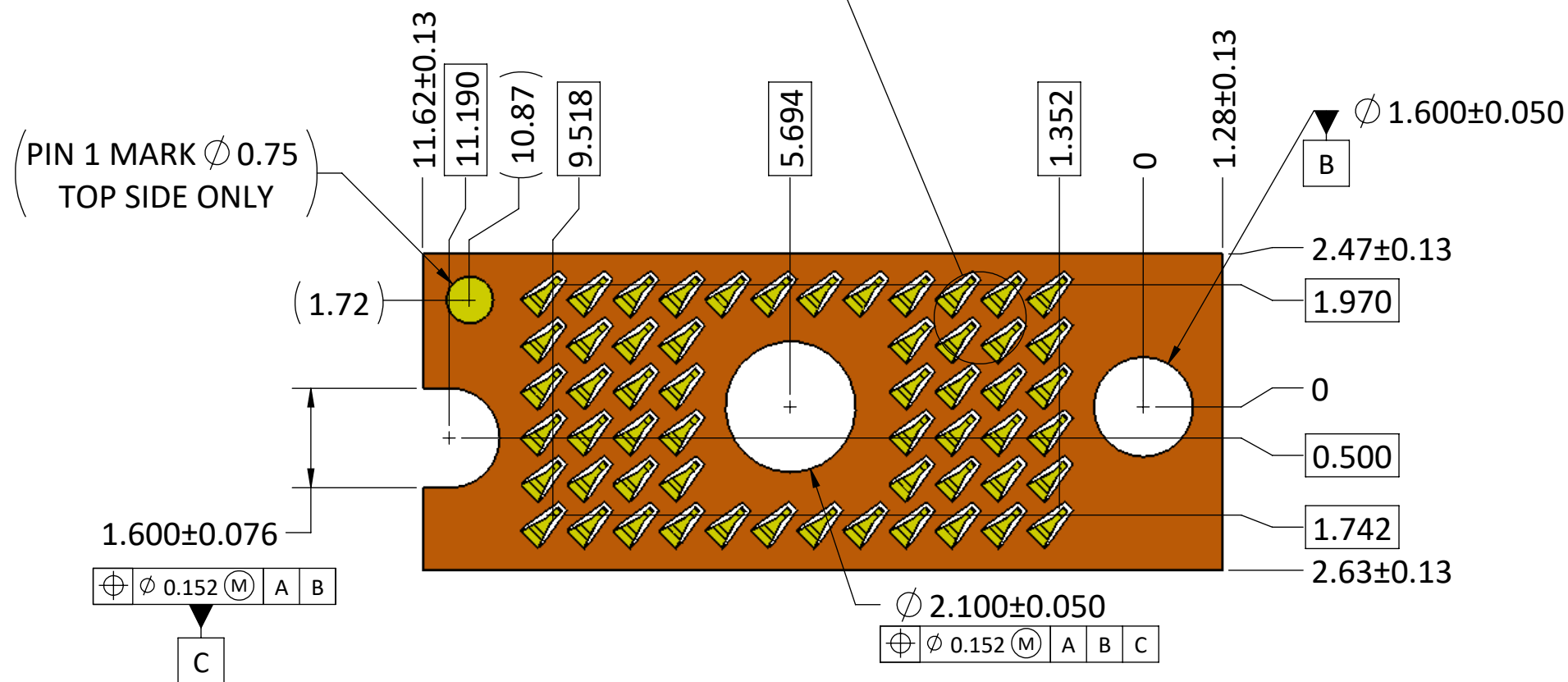

**COMPRESSED**

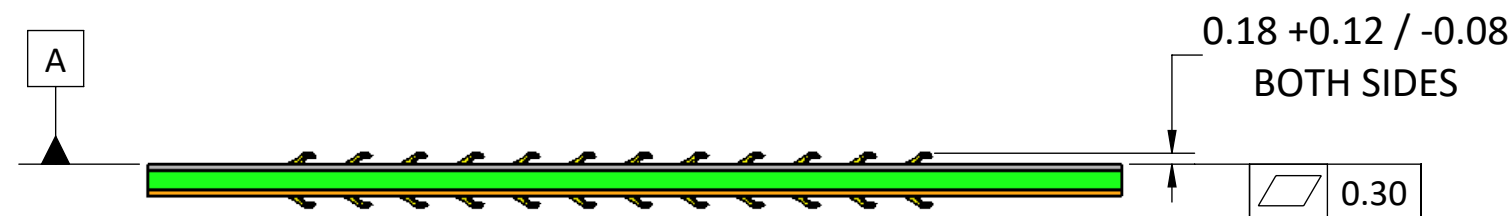

**UNCOMPRESSED**

NOTES (UNLESS OTHERWISE SPECIFIED):

1. INTERPRET DRAWING PER ASME Y14.5M-1994.
2. HALOGEN-FREE PER IPC-4101B.
3. COMPLIANT WITH RoHS DIRECTIVE 2011/65/EU.

4 CENTER MARKS OF CONTACT POSITIONS ARE FOR COMPRESSED STATE

**neconix**  
4020 MOORPARK AVENUE #108  
SAN JOSE, CA 95117 USA  
TEL: 408-530-9393 FAX: 408-530-9383

DIMENSIONS ARE IN  
MM [INCH]  
.X ± 0.13 [.005]  
.XX ± 0.08 [.003]  
.XXX ± 0.025 [.001]  
ANGLE: NO DEC ± 1°  
.X ± 0.5°  
.XX ± 0.25°

MATERIAL: SEE NOTES  
FINISH: SEE NOTES  
DRAWN BY: Jason Wu 03-19-2015  
CHECKED BY: Woody Maynard 03-19-2015  
ENGR APPR:  
MFG APPR:  
QA APPR:

TITLE:  
**LPM INTERPOSER,  
56 POSITIONS LGA-LGA**  
SIZE DWG NUMBER: B+ LPM-056A  
SCALE: 10:1 SHEET 2 OF 5

REVISIONS				
REV	ECN	DESCRIPTION	DATE	APPROVED
A	1231	PRODUCTION RELEASE	04-10-2019	WES TAO

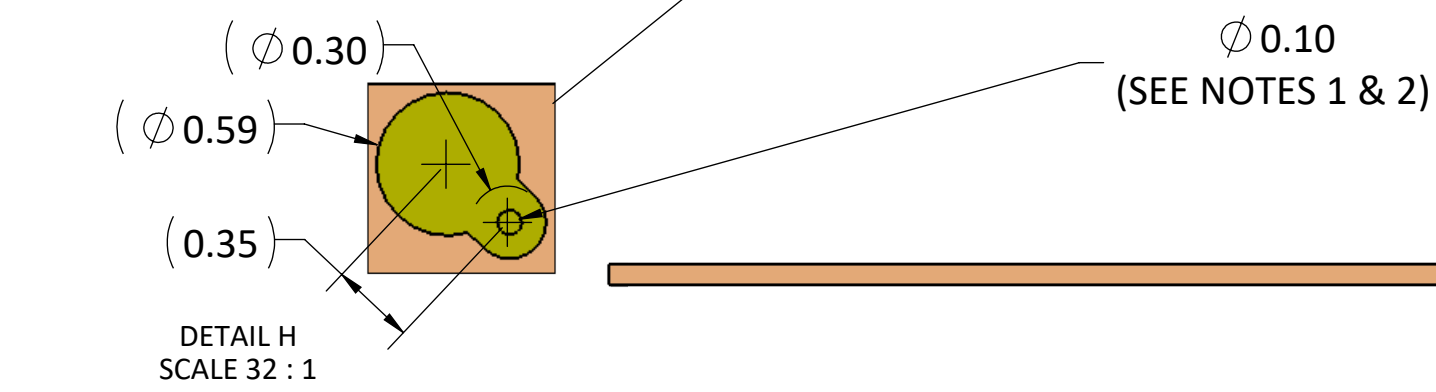
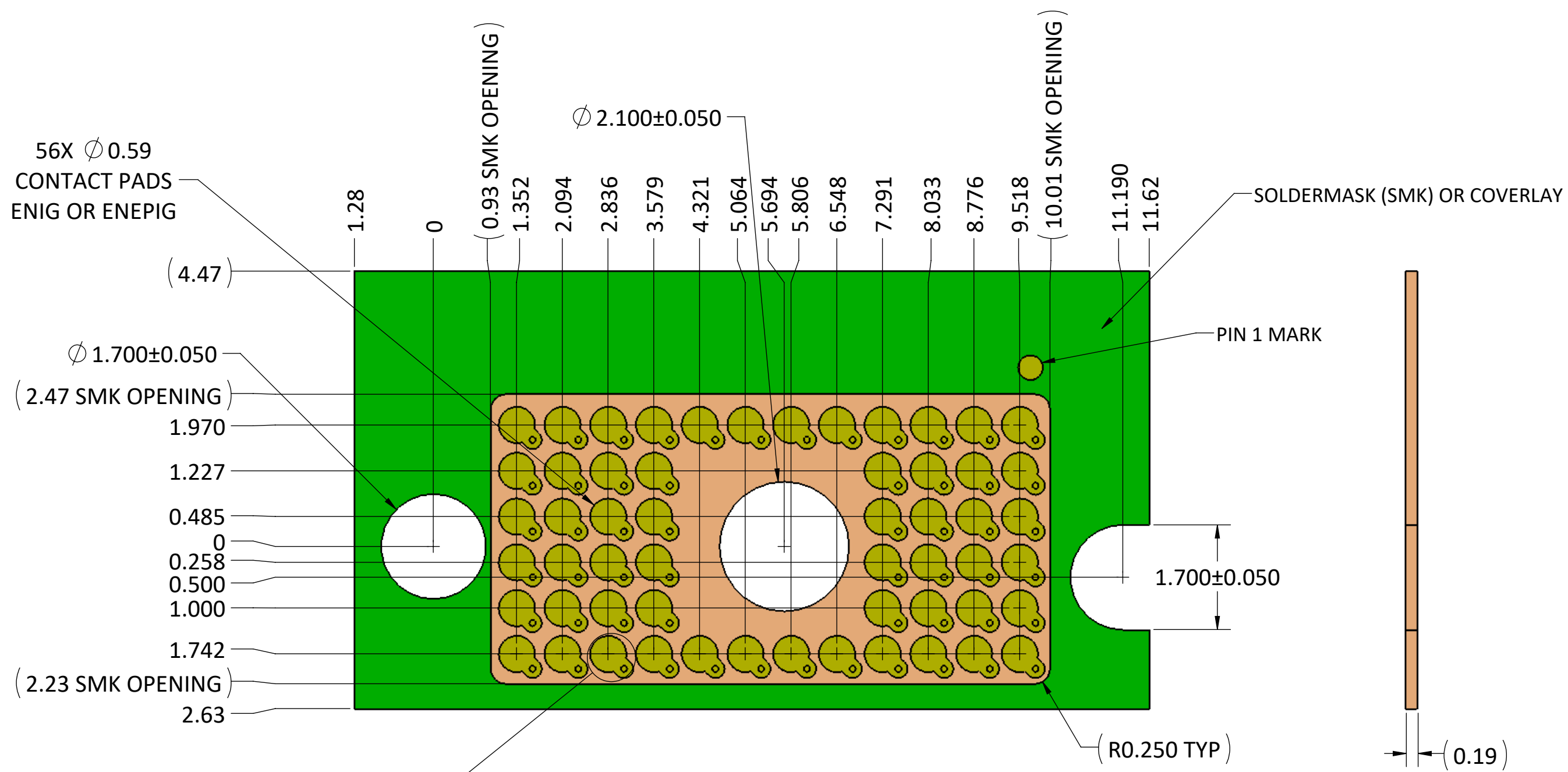

- NOTES:
1. THE PAD GEOMETRY SHOWN ASSUMES A BLIND VIA STACK-UP. IF A THRU-HOLE VIA IS NEEDED, IT IS ACCEPTABLE TO ROTATE THE POSITION OF THE VIAS AS NEEDED TO AVOID INTERFERENCE WITH THE BACK SIDE NUT SOLDER PAD.
  2. IF THE VIA NEEDS TO BE LOCATED WITHIN THE 0.59MM PAD DIAMETER, IT MUST BE FILLED, PLATED, AND PLANARIZED WITH 25UM MAX DIMPLE.

<p>4020 MOORPARK AVENUE #108 SAN JOSE, CA 95117 USA TEL: 408-530-9393 FAX: 408-530-9383</p>	DIMENSIONS ARE IN MM [INCH] .X ± 0.13 [.005] .XX ± 0.08 [.003] .XXX ± 0.025 [.001] ANGLE: NO DEC ± 1° .X ± 0.5° .XX ± 0.25°		MATERIAL: FINISH:		TITLE: <b>RECOMMENDED FPC LAYOUT</b> <b>LPM 56 POSITIONS</b>	
	DRAWN BY: JASON WU 03-19-2015		CHECKED BY:		SIZE: B+	
	ENGR APPR:		MFG APPR:		DWG NUMBER: LPM-056A-FPC	
	QA APPR:		THIRD ANGLE		REV: A	
SCALE: 10:1				SHEET 3 OF 5		

REVISIONS				
REV	ECN	DESCRIPTION	DATE	APPROVED
A	1231	PRODUCTION RELEASE	04-10-2019	WES TAO

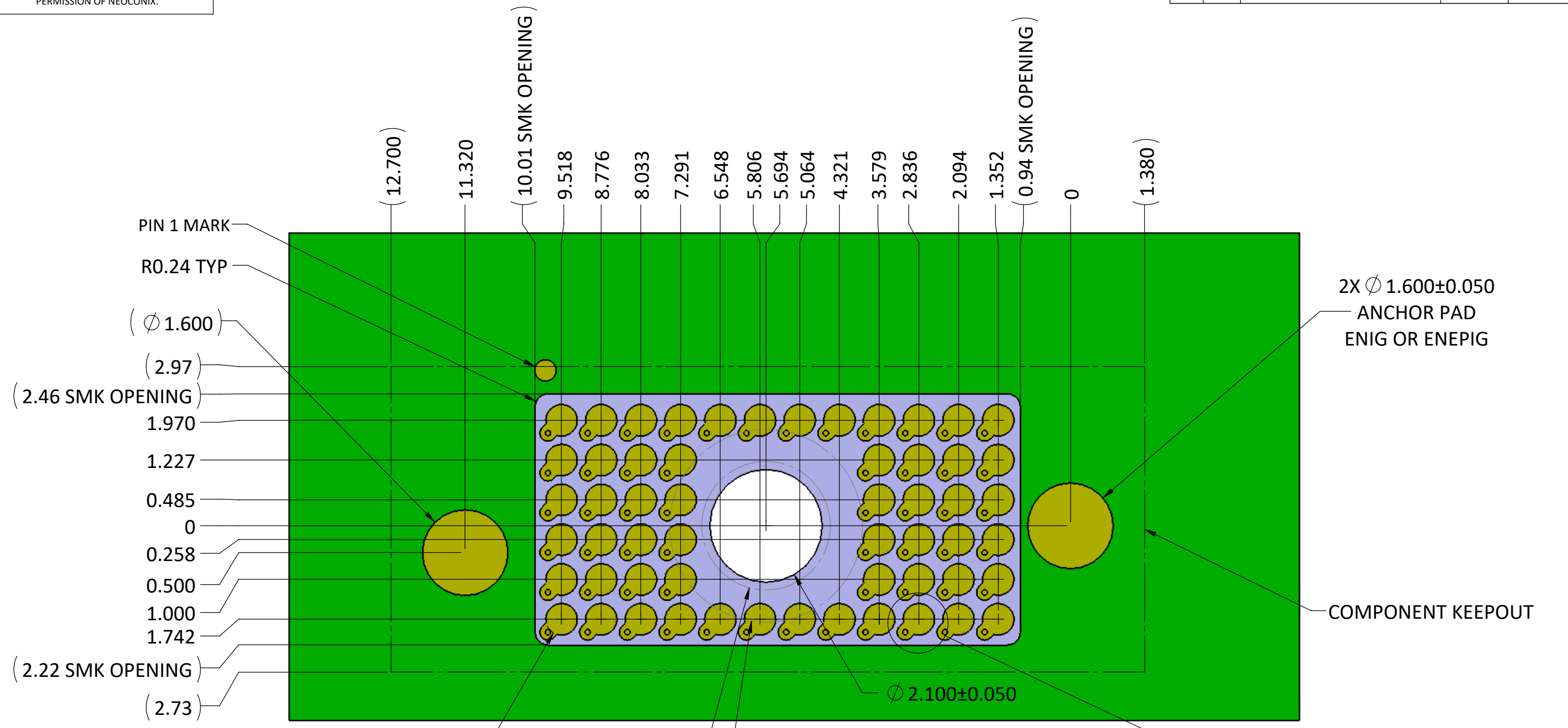

- NOTES:
1. THE PAD GEOMETRY SHOWN ASSUMES A BLIND VIA STACK-UP. IF A THRU-HOLE VIA IS NEEDED, IT IS ACCEPTABLE TO ROTATE THE POSITION OF THE VIAS AS NEEDED TO AVOID INTERFERENCE WITH THE BACK SIDE NUT SOLDER PAD.
  2. IF THE VIA NEEDS TO BE LOCATED WITHIN THE 0.59MM PAD DIAMETER, IT MUST BE FILLED, PLATED, AND PLANARIZED WITH 25UM MAX DIMPLE.

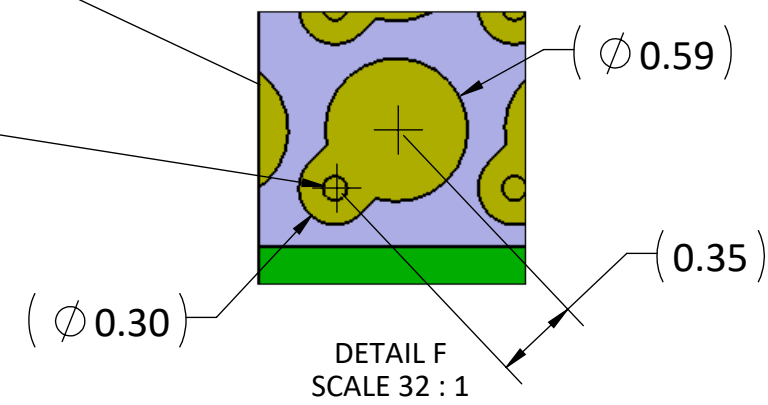
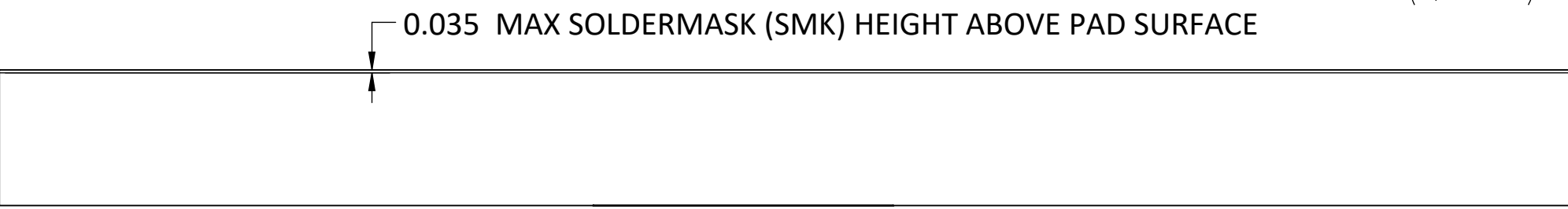

<p>4020 MOORPARK AVENUE #108 SAN JOSE, CA 95117 USA TEL: 408-530-9393 FAX: 408-530-9383</p>	<p>DIMENSIONS ARE IN MM [INCH]</p> <p>.X <math>\pm 0.13</math> [.005] .XX <math>\pm 0.08</math> [.003] .XXX <math>\pm 0.025</math> [.001]</p> <p>ANGLE: NO DEC <math>\pm 1^\circ</math> .X <math>\pm 0.5^\circ</math> .XX <math>\pm 0.25^\circ</math></p>	<p>MATERIAL:</p> <p>FINISH: <input checked="" type="checkbox"/></p> <p>DRAWN BY: JASON WU 03-19-2015</p> <p>CHECKED BY:</p> <p>ENGR APPR:</p> <p>MFG APPR:</p> <p>QA APPR:</p>	<p>TITLE: <b>RECOMMENDED PCB LAYOUT LPM 56 POSITIONS</b></p> <p>SIZE: B+</p> <p>DWG NUMBER: <b>LPM-056A-PCB</b></p> <p>REV: A</p>
	SCALE: 10:1		SHEET 4 OF 5

- PROPRIETARY INFORMATION -  
NO USE OR REPRODUCTION MAY BE MADE OF  
THIS DOCUMENT WITHOUT EXPRESS WRITTEN  
PERMISSION OF NEOCONIX.

REVISIONS				
REV	ECN	DESCRIPTION	DATE	APPROVED
A	1231	PRODUCTION RELEASE	04-10-20190	WES TAO
B	1285	ADD BREAK TABS, STD TOLS	03-01-2021	WES TAO

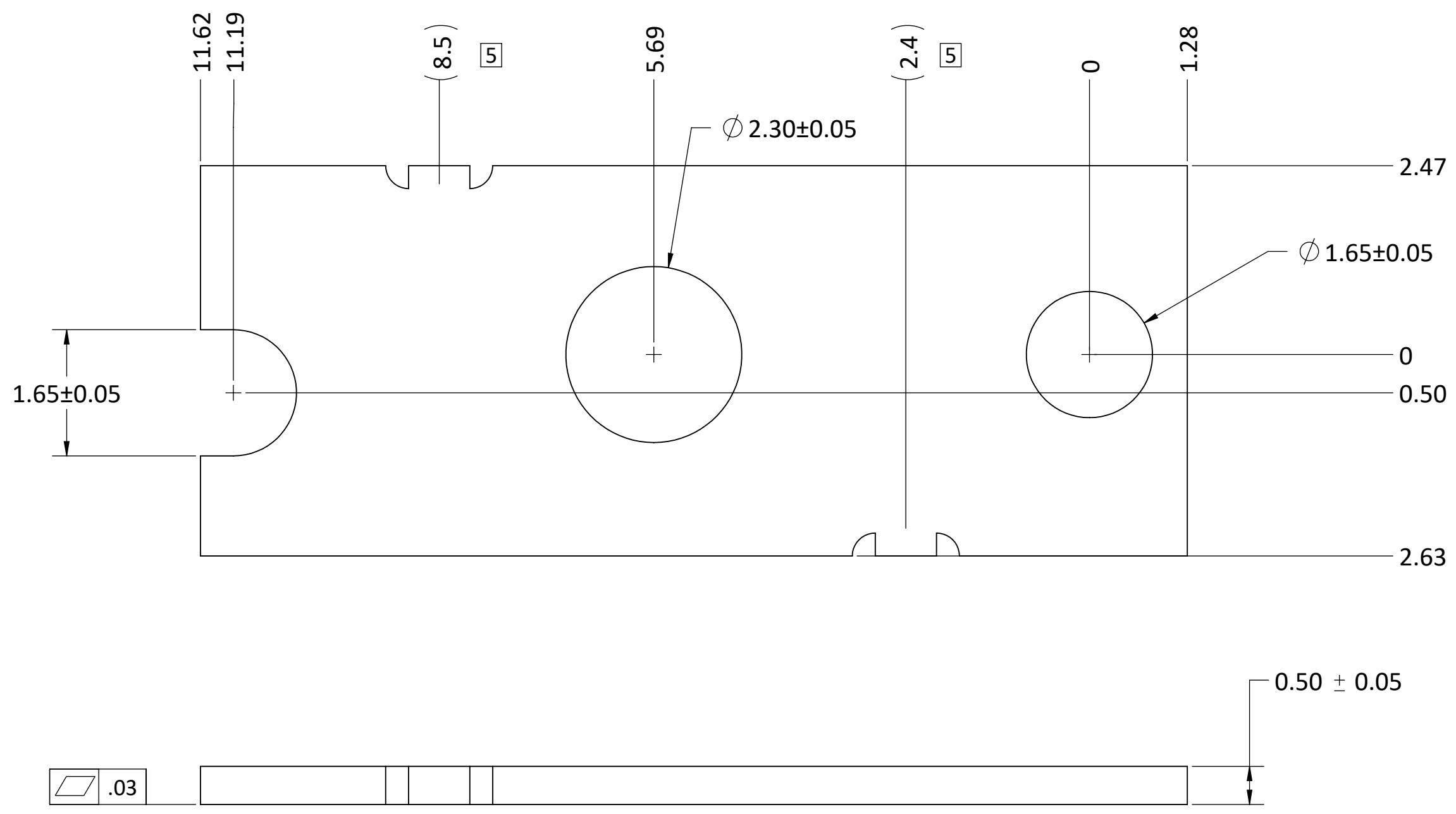

NOTES (UNLESS OTHERWISE SPECIFIED):

1. INTERPRET DRAWING PER ASME Y14.5M-1994.
2. USE THERMOSETTING ADHESIVE FILM TO ATTACH TO FPC.
3. RECOMMEND 0.15MM CLEARANCE BETWEEN EDGE OF ADHESIVE AND EDGE/HOLE FEATURES TO ACCOMODATE ADHESIVE FLOW.
4. MATERIAL: 301 SS FULL HARD
5. BREAK APPROXIMATELY AS SHOWN: NOT TO EXTEND BEYOND EDGE OF STIFFENER



4020 MOORPARK AVENUE #108  
SAN JOSE, CA 95117 USA  
TEL: 408-530-9393 FAX: 408-530-9383

DIMENSIONS ARE IN MM

.X ± 0.13  
.XX ± 0.08  
.XXX ± 0.025  
ANGLE: NO DEC ± °  
.X ± 0.5°  
.XX ± 0.25°

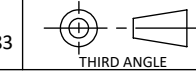

MATERIAL:	SEE NOTES
FINISH:	SEE NOTES
DRAWN BY:	JASON WU 07-31-2015
CHECKED BY:	
ENGR APPR:	
MFG APPR:	
QA APPR:	

TITLE:		STIFFENER, LPM 56 POS	
SIZE	DWG NUMBER:	REV	
B+	LPM-056A-STF	B	
SCALE:	10:1	SHEET	5 OF 5