

## Product Specification: 5-Row Family of Standard Interposers (SPH1)

### FEATURES

- High Performance PCBeam™ Connector Technology
- Product options at 1.27mm, 1.0mm, and 0.8mm pitch
- Thickness options from 0.5mm to 3.0mm
- All assembly hardware included (optional)
- ROHS 2011/65/EU compliant

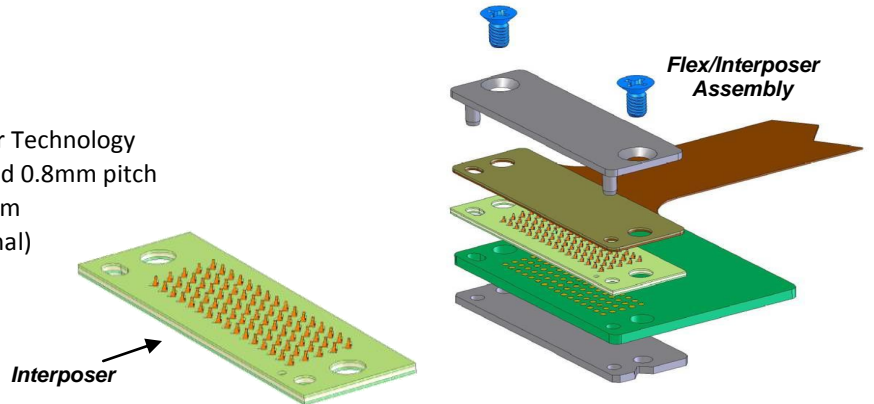

### OVERVIEW

Neoconix’s SPH1 family of 5-row PCBeam™ interposer standard products has been developed for high performance board-to-board and flex-to-board applications. There are five standard configurations available, ranging from 80-positions to 120-positions and from 1.27mm pitch to 0.8mm pitch. Custom variants are also possible. Compatible hardware is available for simple and reliable assembly into the host system. Optionally, Neoconix can further simplify the implementation by also designing and providing the associated FPC.

Standard configurations are as shown below:

ITEM	INTERPOSER PART NUMBER	PITCH (mm)	POSITIONS	MATED HEIGHT	ROWS	COLS	LENGTH (mm)	WIDTH (mm)
1	SPH1-F080A	1.27	80	0.8mm	5	16	31.8	9.9
2	SPH1-F120A	1.27	120	0.8mm	5	24	41.9	9.9
3	SPH1-D120A	1.00	120	0.8mm	5	24	35.7	9.6
4	SPH1-D120B	1.00	120	3.0mm	5	24	35.7	9.6
5	SPH1-C110A	0.80	110	0.5mm	5	22	31.8	10.0

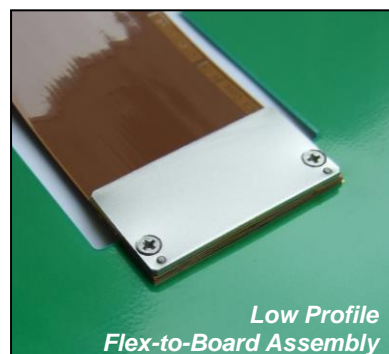
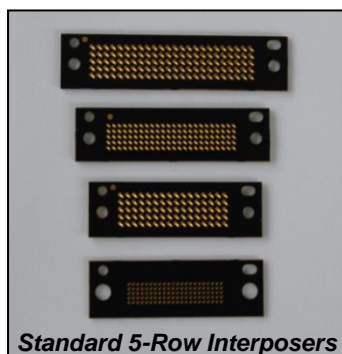

**PCBeam™ TECHNOLOGY BACKGROUND:**

Neoconix interposers are built using innovative PCBeam™ technology. Based on the principles of printed circuit board processing, this lithography & etch based manufacturing method provides unparalleled design flexibility, precision, and performance. Prototype costs and lead times are greatly reduced since no molds are required, and high volume cost-effectiveness is gained through large scale batch processing.

Neoconix' PCBeam interposers offer many features, including the following:

- Continuous, all-metal spring contacts
- Large spring deflection up to 0.50mm to tolerate flatness variations on mating boards
- High current carrying capacity >1.5A
- Excellent signal integrity to 40 Gbps+
- Integrated contact elements – no loose pieces
- Low profile to 0.28mm
- A continuum of available thickness options
- High density capabilities at 0.74mm array pitch and 0.5mm row pitch
- Excellent true position capabilities
- Optional SMT configuration with solder balls pre-attached on one side of interposer
- High volume manufacturing in China

While the standard products here are defined with specific configurations, Neoconix' PCBeam technology inherently has tremendous design flexibility. In many cases, fully custom designs can be built with no new tooling required. Flex circuit design and manufacturing is also available to enable fully integrated flex/interposer assemblies.

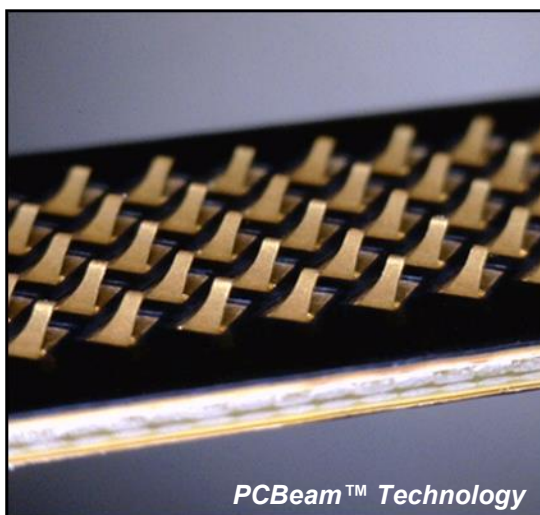

<b>DOCUMENT NUMBER:</b> AS-000017	<b>REV.B</b> 6/10/2016	5-Row Family of Standard Interposers	<b>AUTHOR:</b> WM	<b>Page</b> 2 of 10
--------------------------------------	---------------------------	---	----------------------	------------------------

**5-ROW INTERPOSER SPECIFICATIONS\***
**MECHANICAL**

Contact Configuration.....	single-beam, LGA/LGA
Contact Pitch.....	1.27mm, 1.0mm, 0.8mm
Contact Count.....	80, 110, 120
Typical Load / Contact.....	0.4N (approx. 40g)
Contact Deflection Per Side (1.27, 1.0, 0.8mm pitch).....	0.25mm, 0.20mm, 0.20mm
Contact Deflection Both Sides (1.27, 1.0, 0.8mm pitch).....	0.50mm, 0.40mm, 0.40mm

**ELECTRICAL**

Current Rating** (1.27, 1.0, 0.8mm pitch).....	1.5A, 1.0A, 0.8A per position
Average Resistance.....	< 30mΩ per position
Insertion Loss @ 10GHz (20Gbps), 0.8mm thickness.....	< 1dB
Dielectric Withstanding Voltage.....	100 VAC
Insulation Resistance.....	100 MΩ

**ENVIRONMENTAL**

Operating Temperature.....	-40°C to 105°C
Storage Temperature.....	-40°C to 105°C
Humidity.....	500 hrs, 80% RH, 25°C to 85°C
Heat Aging.....	500 hrs, 100°C
Temperature Cycling.....	1,000 cycles, 0°C to 100°C
Thermal Shock.....	10 cycles, -40°C to 60°C
Salt Spray.....	48 hrs
Mechanical Shock.....	50 g, 3 axis
Random Vibration.....	0.02-0.04 g <sup>2</sup> /Hz, 3 axis
Insertions.....	100 mating cycles

**MATERIALS**

Core Dielectric.....	laminate
Contact Elements.....	copper alloy
Contact Plating.....	15 μin hard Au over Ni
Surface Insulator.....	polyimide

\* Specifications are subject to change without notice.

\*\* Current rating is approximation as it depends on customer's pinout and other design details. Please contact Neoconix for input on your specific design.

<b>DOCUMENT NUMBER:</b> AS-000017	<b>REV.B</b> 6/10/2016	5-Row Family of Standard Interposers	<b>AUTHOR:</b> WM	<b>Page</b> 3 of 10
--------------------------------------	---------------------------	---	----------------------	------------------------

**DIMENSIONAL INFORMATION - INTERPOSERS**

(Example = SPH1-D120A, 120pos)

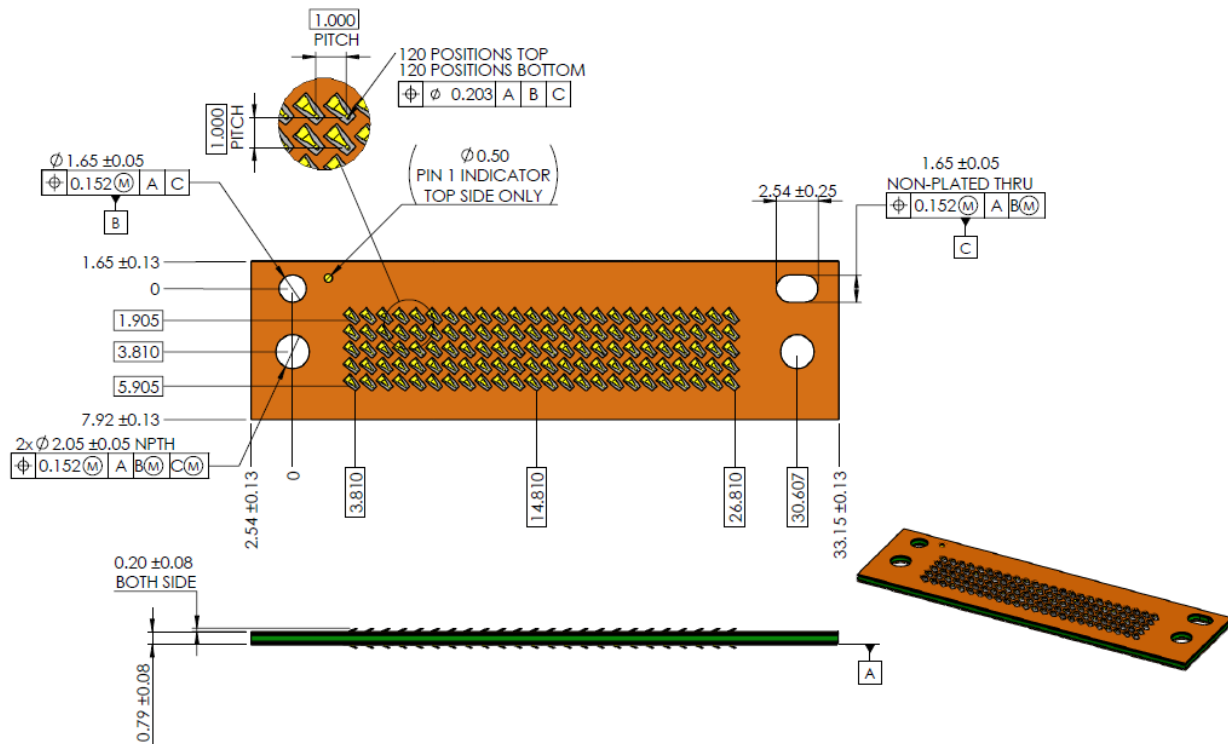

**Note:** This example is for reference only. Please refer to the product drawing for the specific part number of interest.

<b>DOCUMENT NUMBER:</b> AS-000017	<b>REV.B</b> 6/10/2016	5-Row Family of Standard Interposers	<b>AUTHOR:</b> WM	<b>Page</b> 4 of 10
--------------------------------------	---------------------------	---	----------------------	------------------------

**RECOMMENDED FPC DESIGN**

(Example = SPH1-D120A, 120pos)

The recommended pad geometry is described below for reference. The center contact area is 0.65 mm in diameter. The via is located under the “base” of the corresponding contact spring. It is recommended that soldermask or coverlay not be included within the array area.

Recommended plating finishes are ENIG, ENEPIG, or electrolytic hard gold.

The specific FPC layout recommendation is included in the drawing package for each SPH1 part number.

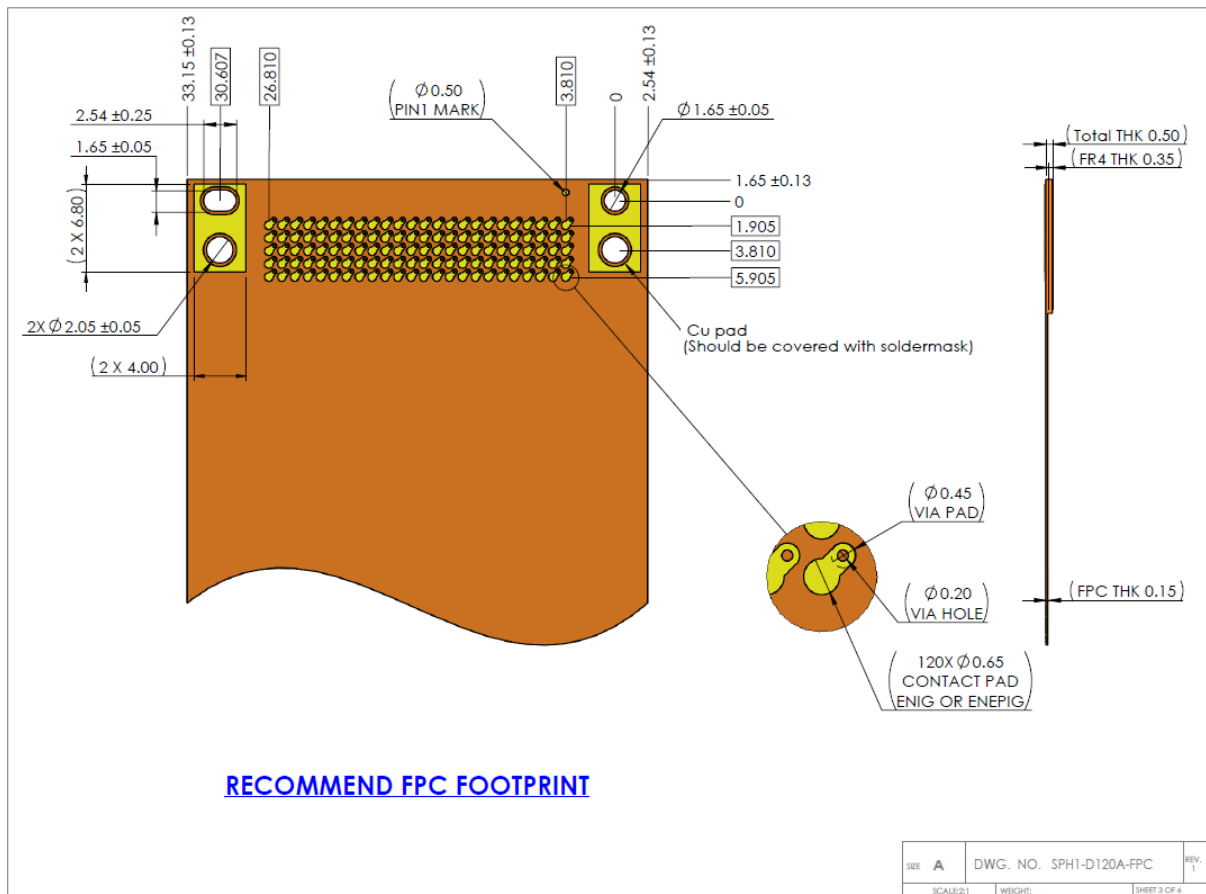

**RECOMMENDED PCB DESIGN**

(Example = SPH1-D120A, 120pos)

The recommended pad geometry for the PCB is analogous to the geometry for the FPC. An example is shown below for reference. Detailed recommendations for each part number are included in each part number's drawing set.

The PCB mating pads must be gold plated with ENIG, ENEPIG, or electrolytic hard gold.

With the FPC or PCB layout, it is possible to deviate from the pad geometry shown, but a Neoconix review is suggested, and a separate tolerance analysis is recommended, especially if the pad size will be smaller than shown below.

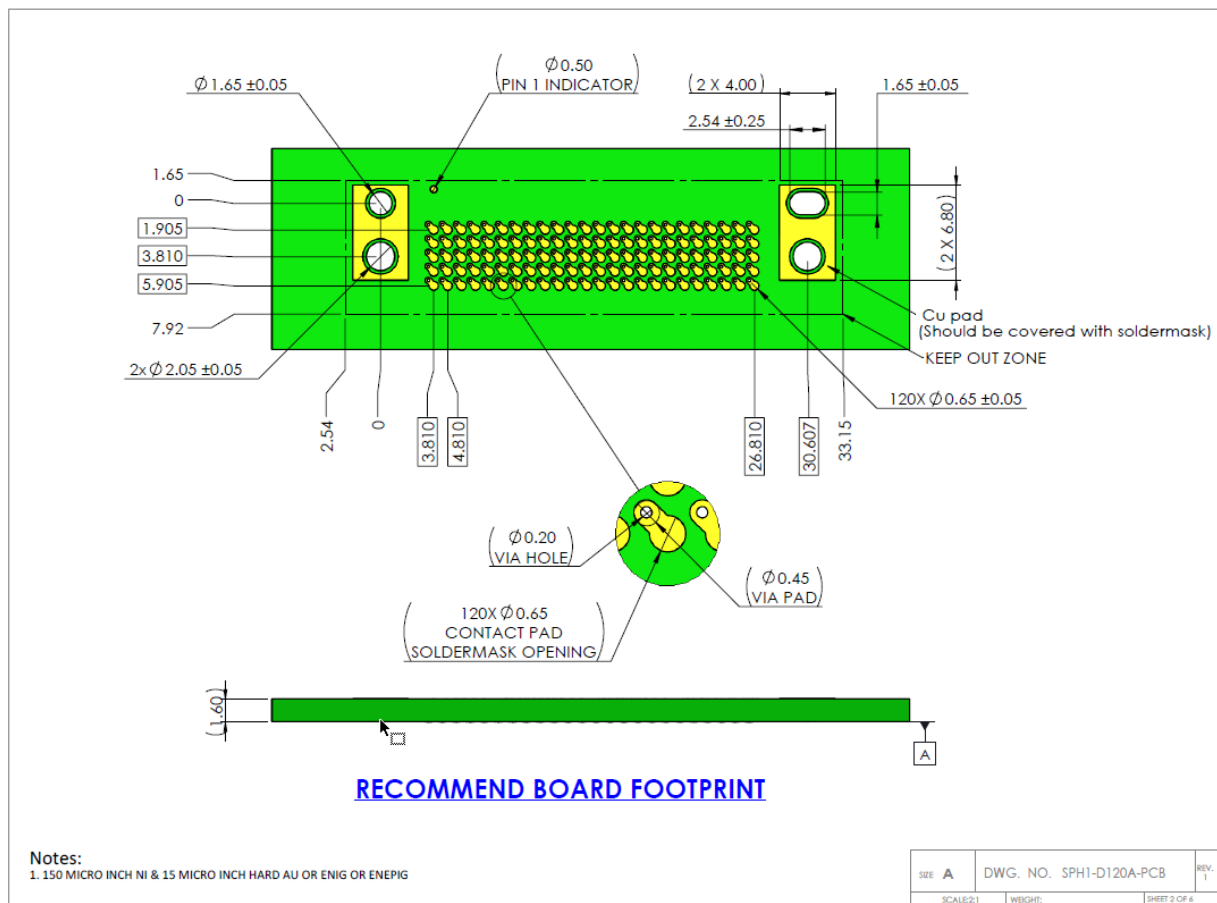

<b>DOCUMENT NUMBER:</b> AS-000017	<b>REV.B</b> 6/10/2016	5-Row Family of Standard Interposers	<b>AUTHOR:</b> WM	<b>Page</b> 6 of 10
--------------------------------------	---------------------------	---	----------------------	------------------------

**COMPRESSION HARDWARE (Optional)**

(Example = SPH1-D120A, 120pos)

Neoconix has designed hardware compatible with the SPH1 interposer product family. The hardware includes:

- (1) Upper backer plate with integrated alignment pins
- (2) Lower backer plate with threaded holes
- (3) Flathead M2 screws

The specific backer plate layout recommendation is included in the drawing package for each SPH1 part number.

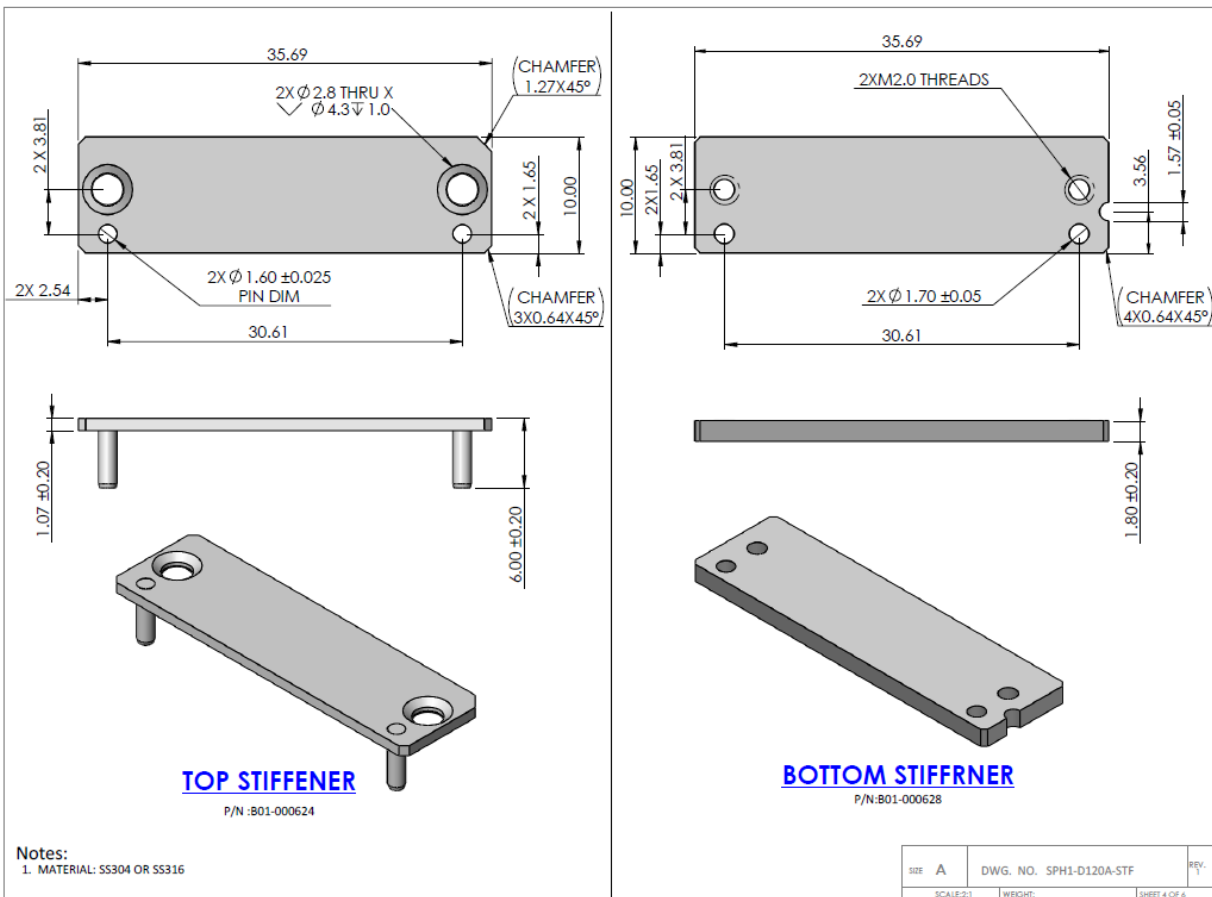

Several pin/screw lengths are available, depending on the overall assembly thickness. The table below shows the recommended length based on your specific assembly stack-up.

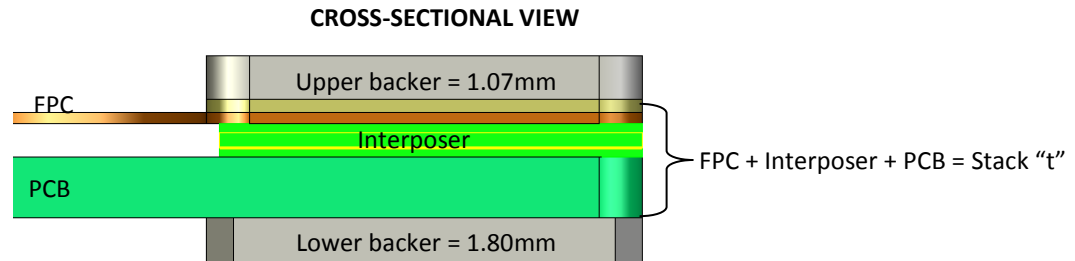

**Recommended Pin & Screw Length**

Stack "t" (total,mm)	Rec. Length (mm)	P/N Suffix Lxxx
<1.9 mm	5.0	L050
1.9-3.5	6.0	L060
3.5-5.1	8.0	L080
5.1-6.7	10.0	L100
6.7-9.8	12.0	L120



## ASSEMBLY INSTRUCTIONS

The proper assembly sequence is as follows:

**IMPORTANT:** Handle interposers only by edges, and avoid touching PCBeam contact elements. Likewise, avoid touching (and potentially contaminating) the gold mating pads on PCB & FPC. The use of latex gloves is recommended.

1. Temporarily insert *Upper Backer* onto the interposer side (top side) of the *Lower PCB*.
2. Remove protective lining on *Lower Backer* to expose underlying adhesive.
3. Using the alignment pins from *Upper Backer* as a guide, carefully attach the *Lower Backer* onto the bottom side of the *Lower PCB*. Press firmly to engage the adhesive.
4. Remove the *Upper Backer* from the *Lower PCB*
5. Insert the *Upper Backer* over the *Upper FPC* (or PCB), using the integrated dowel pins for alignment.
6. Slip the interposer onto the pad-side of the *Upper FPC*, using the dowel pins for alignment.
7. Attach the flex/interposer/backer assembly to the *Lower PCB/backer*, using the dowel pins for alignment.
8. While applying finger pressure on the center of the *Upper Backer*, attach the two screws from the Upper Backer into the threaded *Lower Backer* to secure the assembly together. The recommended torque is 2.5 inch-lbs.

Compression hardware can be custom designed when desired. Please ensure that the hardware solution provides sufficient rigidity assuming 0.4N of contact force is applied by each of the contact element positions. For example, an 80-position interposer would exert approximately 32N (or 7Lbs) of normal force.

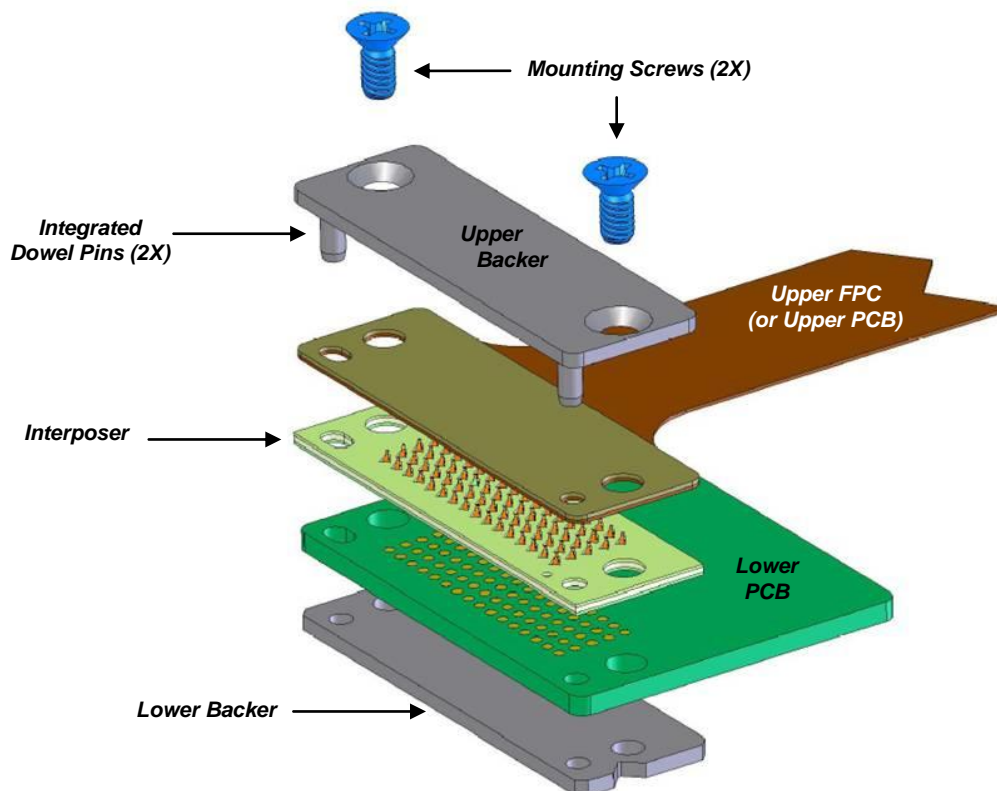

<b>DOCUMENT NUMBER:</b> AS-000017	<b>REV.B</b> 6/10/2016	5-Row Family of Standard Interposers	<b>AUTHOR:</b> WM	<b>Page</b> 9 of 10
--------------------------------------	---------------------------	---	----------------------	------------------------

**HANDLING GUIDELINES**

- The use of latex gloves is recommended when handling interposers. As with any normal force connector, avoid touching contact tips and handle the product only by its edges.
- When clamping the assembly together, please ensure that the force is applied uniformly. Force should be applied vertically through the z-axis and not in an angled direction.
- Cleaning is typically not needed if the product is kept in original packaging. When necessary, cleaning can be employed with the use of compressed air. Direct the flow of air in the direction that the contact elements are pointing. Cleaning can also be performed with an ultrasonic bath of isopropyl alcohol (IPA). A 5 minute soak can be followed by a 10 minute bake at 65°C.
- When not in use, please keep product stored in original packaging.

**ORDERING INFO**

To obtain a quotation, please contact the Neoconix sales office at [sales@neoconix.com](mailto:sales@neoconix.com) or 408-530-9393. The SPH1 interposers are available for purchase, as are the compatible hardware items.

When purchasing upper backer plates and screws, please include the 3-digit extension corresponding to the desired pin and screw length (DIM 'D'). For example, the part number B01-000622-L060 refers to an upper backer with pin length 6mm.

Custom interposers and hardware are also available from Neoconix. Please contact the factory to request a quotation.

**Corporate Headquarters:**

Neoconix, Inc.  
2355-C Paragon Dr.  
San Jose, CA 95131  
(408) 530-9393 (phone)  
(408) 530-9383 (fax)  
<http://www.neoconix.com>

**REVISION HISTORY**

Rev	Date	ECN	Description
Rev A	11/3/2011	N/A	Initial release.
Rev B	6/10/2016	1175	Update part numbers, contact info, hardware ordering info, other misc updates.

<b>DOCUMENT NUMBER:</b> AS-000017	<b>REV.B</b> 6/10/2016	5-Row Family of Standard Interposers	<b>AUTHOR:</b> WM	<b>Page</b> 10 of 10
--------------------------------------	---------------------------	---	----------------------	-------------------------